

Gepäckträger Honda VFR 800 GPT.01.208.100

Prüfen Sie nach 50 Km alle Verbindungen auf festen Sitz.

Please proof all Screws after 50 Km for fixing.

Das SW-MOTECH Team wünscht Ihnen eine gute Fahrt.

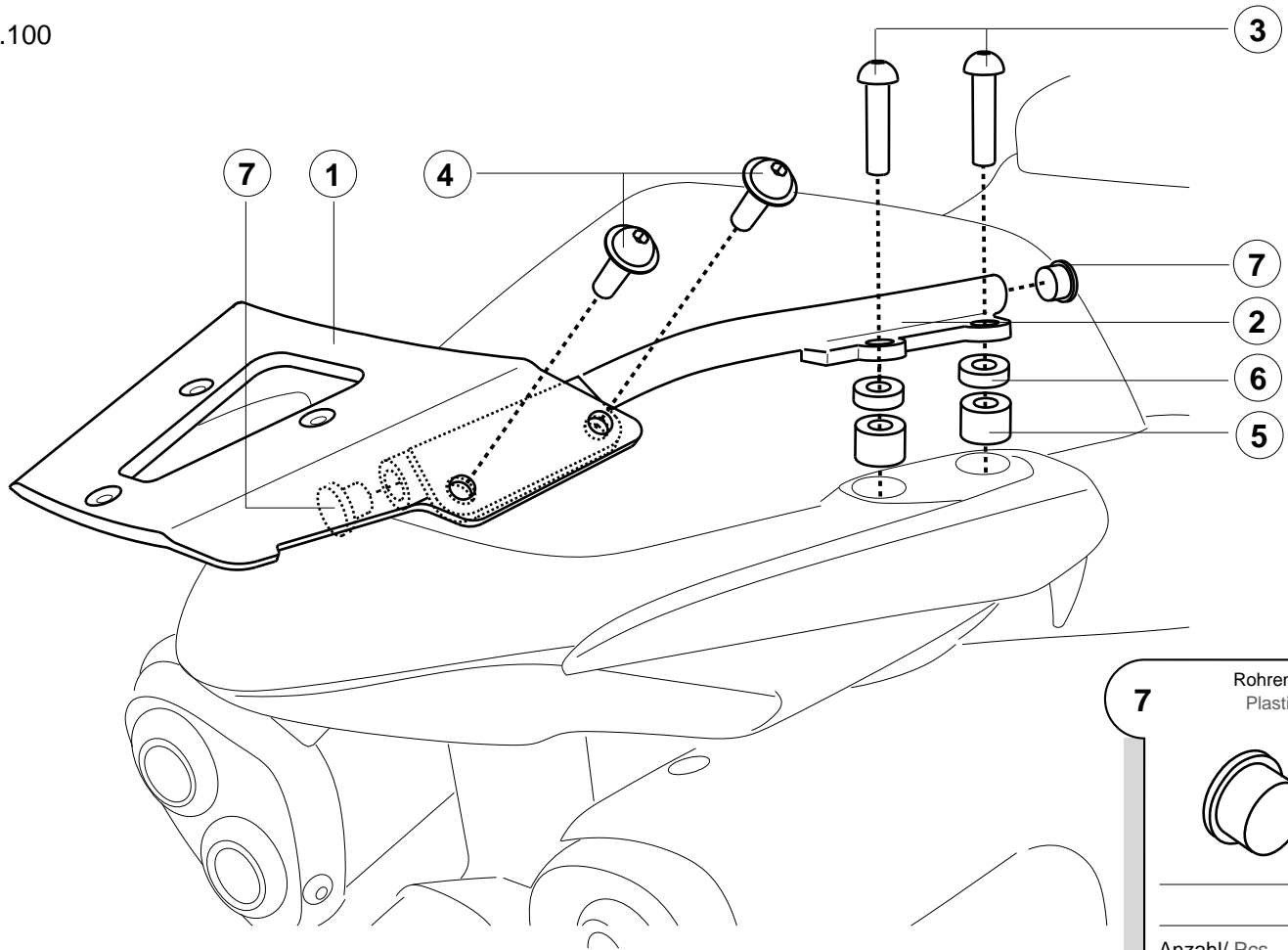

SW- MOTECH GmbH & Co. KG
 Auf der Neustadt 16
 35282 Rauschenberg
 -Germany-

Tel.: ++ 49 (0) 6425 820 280

Fax: ++ 49 (0) 6425 820 281

www.sw-motech.com



1 Top Case Träger
Top Case Carrier

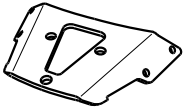

GPT.01.208.001

Anzahl/ Pcs. 1

2 Ausleger
Frame tubes

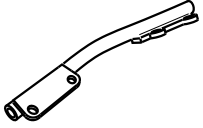

GPT.01.208.910L/R

Anzahl/ Pcs. 2

3 Linsenschraube o. Flansch
Lenshead Screw

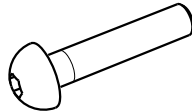

M8 x 60 ISO 7380

Anzahl/ Pcs. 4

4 Linsenschraube
Lenshead

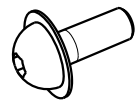

M8 x 20 ISO 7380

Anzahl/ Pcs. 4

5 Distanzbuchse
Distance



Da=20 Di=8,2 h=15

Anzahl/ Pcs. 4

6 Distanzbuchse
Distance



Da=20 Di=8,2 h=5

Anzahl/ Pcs. 4

7 Rohrendkappe
Plastic Cover

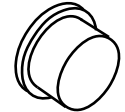

Anzahl/ Pcs. 4