

TRIUMPH Sprint ST 1050 Bj. 05

Alu-Rack Montagehinweise

Alle vom Motorrad gelösten Schrauben sind gemäß Herstellerangaben wieder zu montieren, oder mit von SW-MOTECH gelieferten Schrauben zu ersetzen. Falls nicht anderweitig definiert, diese Schrauben nach Tabelle anziehen.

M6	9,6 Nm
M8	23 Nm
M10	46 Nm

Gegebenenfalls Schrauben mit flüssiger Schraubensicherung einkleben.

Prüfen Sie nach 50 km alle Verbindungen auf festen Sitz.

Max. Zuladung 7,5 Kg inklusive Koffer und Adapter. Ist das Zuladungsgewicht des Fahrzeuges durch den Hersteller limitiert, gelten diese Grenzwerte.

SW-MOTECH GmbH & Co. KG
 Bahnhofstrasse 44d
 35282 Rauschenberg
 -Germany-

Tel.: ++ 49 (0) 6425 816 800

Fax: ++ 49 (0) 6425 816 810

www.sw-motech.com

Alu-Rack Mounting Instructions

SW-MOTECH products should be installed by a qualified, experienced motorcycle technician. If you are unsure of your ability to properly install a product, please have the product installed by your local motorcycle dealer. SW-MOTECH takes no responsibility for damages caused by improper installation.







All screws, bolts and nuts, including all replacement hardware provided by SW-MOTECH, should be tightened to the torque specified in the OEM maintenance manual for your motorcycle. If no torque specifications are provided in the OEM maintenance manual, the following torques may be used:

M6	9,6 Nm
M8	23 Nm
M10	46 Nm

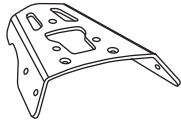
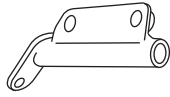
All screws, bolts and nuts should be checked after driving the first 50 km to ensure that all are tightened to the proper torque.

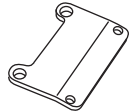
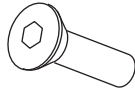
Medium strength liquid thread-locker (i.e., "Locktite") should be used to secure all screws, bolts and nuts.

Max. Load On Rear Carrier: 7,5 Kg (16,5 lbs) inclusive case and adapter or the motorcycle manufacturer's weight limit, whichever is less.

<p>1 Alu-Rack Alu-Rack</p>  <p>GPT.11.527.001 B/S Anzahl/ Pcs. 1</p>	<p>4 Unterbau Bed-Bracket</p>  <p>GPT.11.527.921/922 Anzahl/ Pcs. 2 (L/R)</p>	<p>8 Rohrendkappe Cap</p>  <p>KES.00.18,3-3,5.02 Anzahl/ Pcs. 2</p>
<p>2 Anbaublech Fixing Bracket</p>  <p>GPT.11.527.003 Anzahl/ Pcs. 1</p>	<p>5 Senkkopfschraube mit Innensechskant Countersunk Screw</p>  <p>schwarz/silber M8 x 25 DIN 7991 Anzahl/ Pcs. 6</p>	
<p>3 Linsenkopfschraube Lenshead Screw</p>  <p>schwarz/black M6 x 16 ISO 7380 Anzahl/ Pcs. 4</p>	<p>6 Senkscheibe Countersunk Washer</p>  <p>schwarz/silber SE.00.084.01/02 Anzahl/ Pcs. 4</p>	
	<p>7 Distanzbuchse Spacer</p>  <p>Da:20 Di:8,4 h:5 Anzahl/ Pcs. 2</p>	

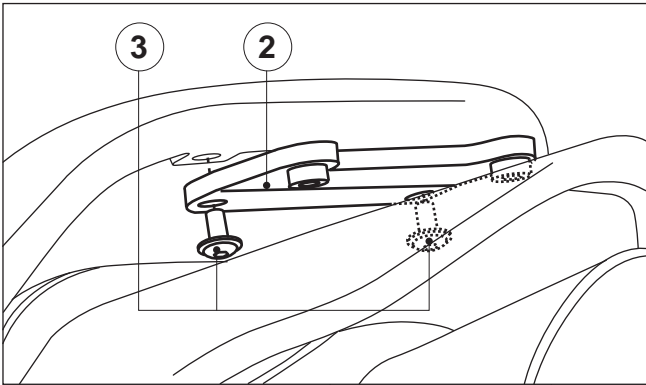

! Achtung: Falls die Montage einer Adapterplatte vorgesehen ist, MÜSSEN die Haltenocken am Alu-Rack vor dessen Anbau am Motorrad verschraubt werden.

Attention: Cam-locks from adapter kit MUST be installed before attaching the alu-rack to the bike.

