

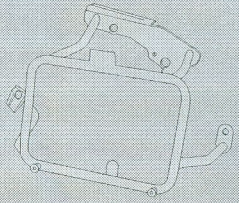

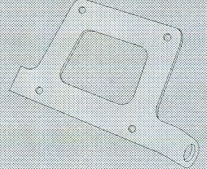

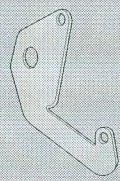

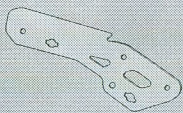



PLR7703 - KLR7703

PORTAVALIGIE LATERALE SPECIFICO - SPECIFIC TUBULAR SIDE-CASE HOLDER - PORTE-VALISES LATÉRAUX SPÉCIFIQUE
 SPEZIFISCHES STAHLROHR-SEITENTRAEGER - PORTA MALETAS LATERALES ESPECÍFICO - TRONCO LADO ESPECÍFICO









KTM ADVENTURE 1190 R (2013)

N°	Descrizione	Caratteristiche	Codice	Quantità	
1	Supporto - Support - Support Halterung - Soporte - Apoio			2 (Dx,Sx)	
2	Supporto - Support - Support Halterung - Soporte - Apoio	Sp. 3mm	GL2412	1	
3	Supporto - Support - Support Halterung - Soporte - Apoio	Sp. 4mm	GL2407	2 (Dx,Sx)	
4	Supporto - Support - Support Halterung - Soporte - Apoio	Sp. 4mm	GL2410	2 (Dx,Sx)	
5	Vite - Screw Vis - Schraube Tornillo - Parafuso	TSCEI M8x20	820TSP	2	
6	Vite - Screw Vis - Schraube Tornillo - Parafuso	TSCEI M8x30	830TSP	2	
7	Vite - Screw Vis - Schraube Tornillo - Parafuso	TSCEI M8x45	845TSP	2	
8	Vite - Screw Vis - Schraube Tornillo - Parafuso	TBEI M6x20	620TBEI	2	
9	Vite - Screw Vis - Schraube Tornillo - Parafuso	TBEI M6x25	625TBEI	2	
10	Vite - Screw Vis - Schraube Tornillo - Parafuso	TBEI M8x40	840TBEI	1	
11	Vite - Screw Vis - Schraube Tornillo - Parafuso	TBEI M8x55	855TBEI	1	
12	Vite - Screw Vis - Schraube Tornillo - Parafuso	TBEI M8x60	860TBEI	1	
13	Vite - Screw Vis - Schraube Tornillo - Parafuso	TBEI M8x75	875TBEI	1	

PLR7703 - KLR7703

PORTAVALIGIE LATERALE SPECIFICO - SPECIFIC TUBULAR SIDE-CASE HOLDER - PORTE-VALISES LATÉRAUX SPÉCIFIQUE
 SPEZIFISCHES STAHLROHR-SEITENTRAEGER - PORTA MALETAS LATERALES ESPECÍFICO - TRONCO LADO ESPECÍFICO

KTM ADVENTURE 1190 R (2013)

N°	Descrizione	Caratteristiche	Codice	Quantità	
14	Distanziale - Spacer Entretoise - Distanzstueck Distanciador - Espaçador	Ø16x12 Foro 12mm	C16L12F12FET	2	
15	Distanziale - Spacer Entretoise - Distanzstueck Distanciador - Espaçador	Ø16x18 Foro 8,5mm	C16L18F8,5ALT	2	
16	Distanziale - Spacer Entretoise - Distanzstueck Distanciador - Espaçador	Ø18x10 Foro 8mm	C18L10F8	2	
17	Distanziale - Spacer Entretoise - Distanzstueck Distanciador - Espaçador	Ø18x25 Foro 8mm	C18L25F8	2	
18	Rondella - Washer Rondelle - Scheibe Arandela - Arruela	Ø8mm	814RON	4	
19	Rondella - Washer Rondelle - Scheibe Arandela - Arruela	Ø6x18	618RON	4	
20	Chiave Per Viti A Testa Speciale - Special Key Cle Speciale - Spezialschlüssel Llave Para Tornillos Con Cabeza Especial	-	-	1	
21	Dado - Bolt - Ecrou Mutter - Tuerca - Porca	Dado M6 Auto Bloccante Flangiato Ribassato	6DADIABFN	4	

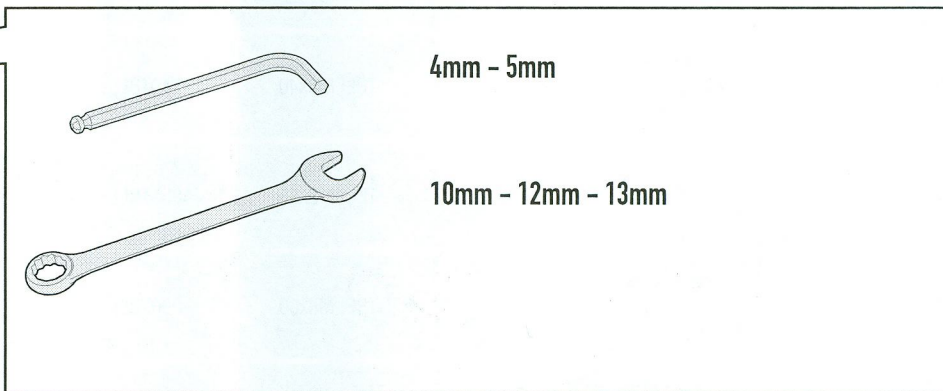
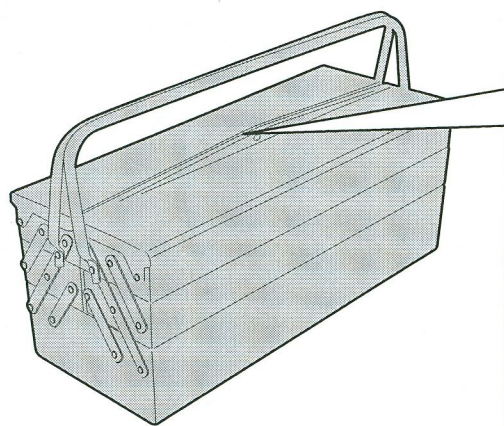

4mm - 5mm

10mm - 12mm - 13mm



PLR7703 - KLR7703

PORTAVALIGIE LATERALE SPECIFICO - SPECIFIC TUBULAR SIDE-CASE HOLDER - PORTE-VALISES LATÉRAUX SPÉCIFIQUE
SPEZIFISCHES STAHLROHR-SEITENTRAEGER - PORTA MALETAS LATERALES ESPECÍFICO - TRONCO LADO ESPECÍFICO

KTM ADVENTURE 1190 R (2013)

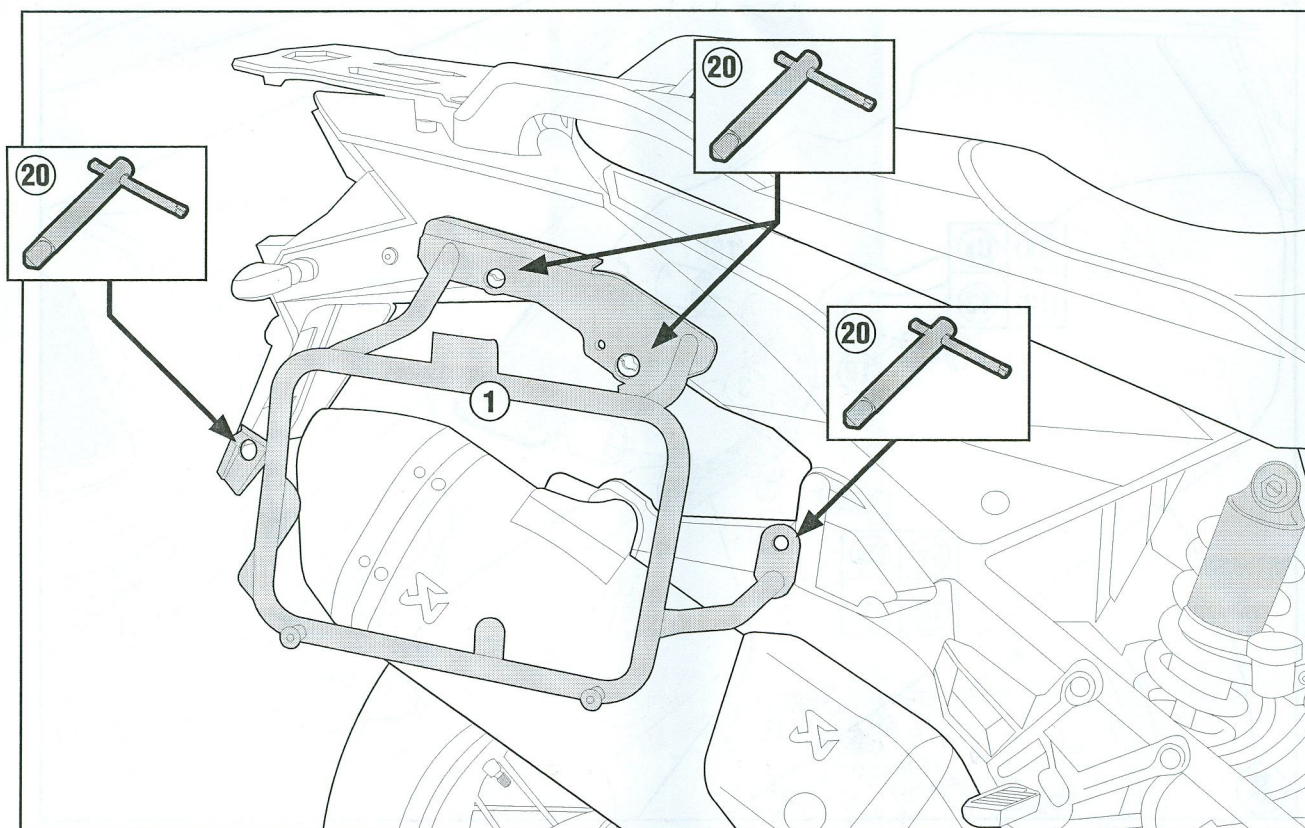
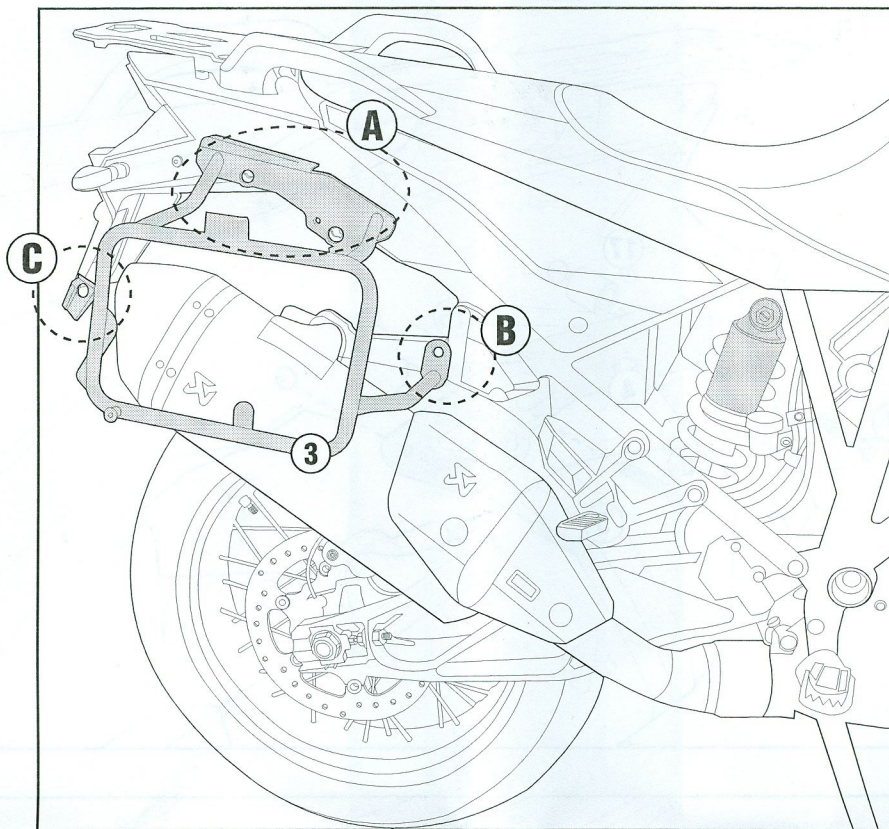

PLR7703 - KLR7703

PORTAVALIGIE LATERALE SPECIFICO - SPECIFIC TUBULAR SIDE-CASE HOLDER - PORTE-VALISES LATÉRAUX SPÉCIFIQUE
SPEZIFISCHES STAHLROHR-SEITENTRAEGER - PORTA MALETAS LATERALES ESPECÍFICO - TRONCO LADO ESPECÍFICO

KTM ADVENTURE 1190 R (2013)

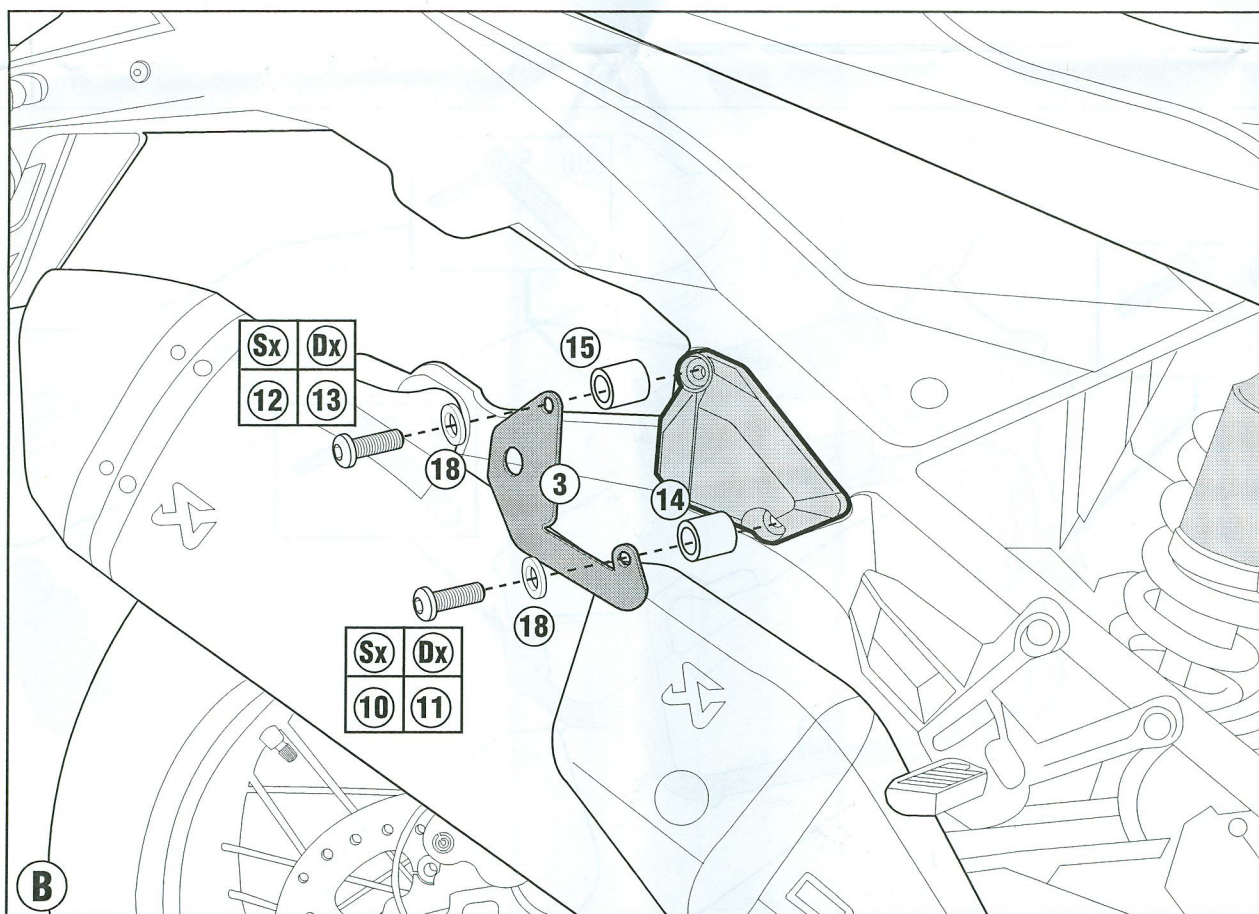
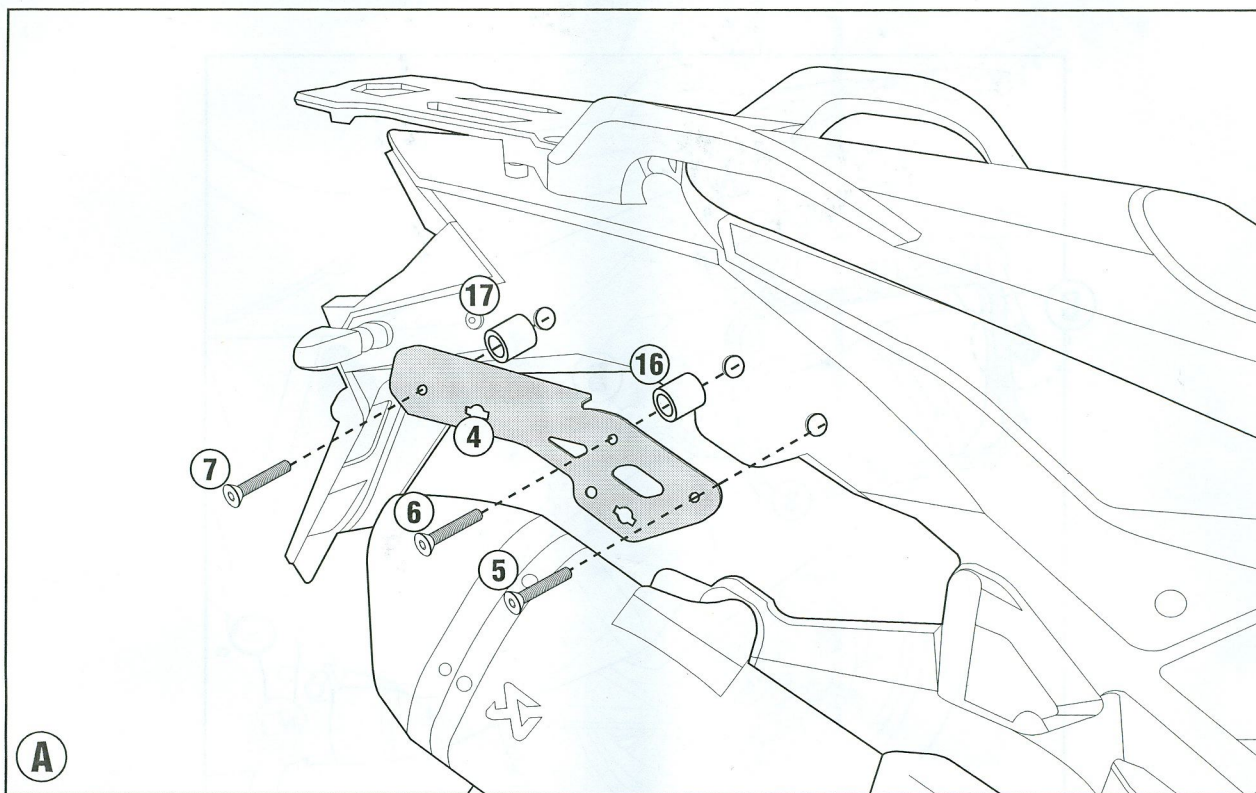

PLR7703 - KLR7703

PORTAVALIGIE LATERALE SPECIFICO - SPECIFIC TUBULAR SIDE-CASE HOLDER - PORTE-VALISES LATÉRAUX SPÉCIFIQUE
SPEZIFISCHES STAHLROHR-SEITENTRAEGER - PORTA MALETAS LATERALES ESPECÍFICO - TRONCO LADO ESPECÍFICO

KTM ADVENTURE 1190 R (2013)

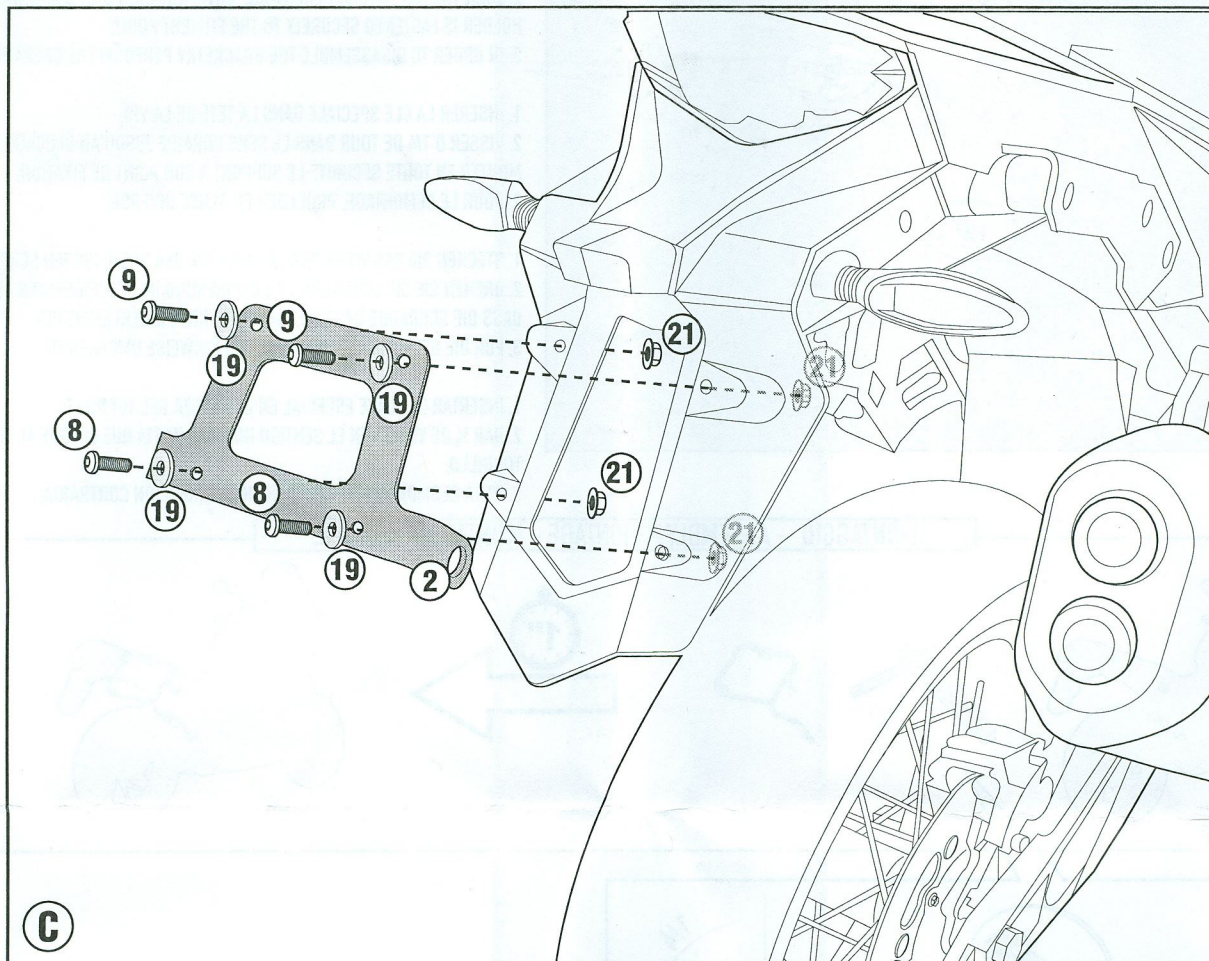

PLR/PLXR

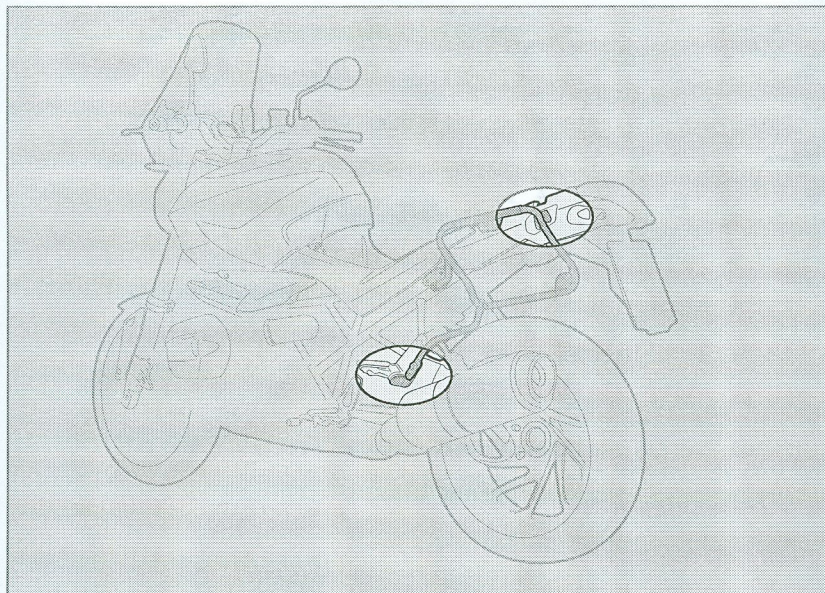

1. INSERIRE L'ATTREZZO NELLA TESTA DELLA VITE SPECIALE;
2. RUOTARE DI 1/4 DI GIRO IN SENSO ORARIO FINO A CHE LA ROTAZIONE NON TERMINA E SI AVVERTE LO SCATTO;
3. PER SMONTARE PROCEDERE IN SENSO INVERSO.

1. INSERT THE SPECIAL KEY INTO THE HEAD OF THE SCREW;
2. TURN THE KEY ¼ TURN CLOCKWISE UNTIL ROTATION STOPS AND THE SIDE CASE HOLDER IS FASTENED SECURELY TO THE FITMENT POINT;
3. IN ORDER TO DISASSEMBLE THE BRACKETRY PERFORM THE OPERATION IN REVERSE.

1. INSERER LA CLE SPECIALE DANS LA TÊTE DE LA VIS;
2. VISSER D'1/4 DE TOUR DANS LE SENS HORAIRE JUSQU'AU BLOCAGE DE LA VIS POUR MONTER EN TOUTE SECURITE LE SUPPORT A SON POINT DE FIXATION;
3. POUR LE DEMONTAGE, PROCEDER EN SENSE INVERSE.

1. STECKEN SIE DAS WERKZEUG IN DEN KOPF DER SPEZIFISCHEN SCHRAUBE;
2. DREHEN SIE DIE SCHRAUBE 1 / 4 UMDREHUNG IM UHRZEIGERSINN BIS SIE BEMERKEN, DASS DIE SCHRAUBE IM BEFESTIGUNGSPUNKT EINGEKLEMMT IST;
3. FÜR DIE DEMONTAGE FOLGEN SIE DEN HINWEISE UMGEKEHRT.

1. INSERTAR LA LLAVE ESPECIAL EN LA CABEZA DEL TORNILLO
2. DAR ¼ DE VUELTA EN EL SENTIDO HORARIO HASTA QUE LLEGUE AL TOPE Y SE VEA EL TORNILLO;
3. PARA DESMONTARLO PROCEDER EN LA DIRECCIÓN CONTRARIA;

MONTAGGIO - ASSEMBLY - MONTAGE - MONTAGE - MONTAJE

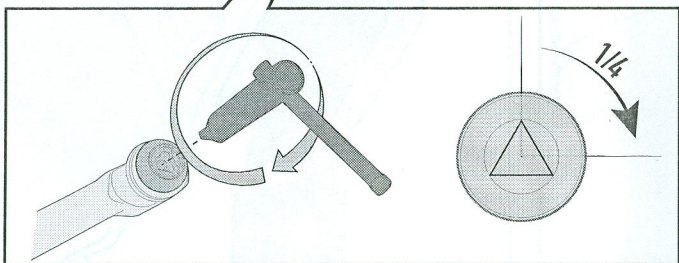
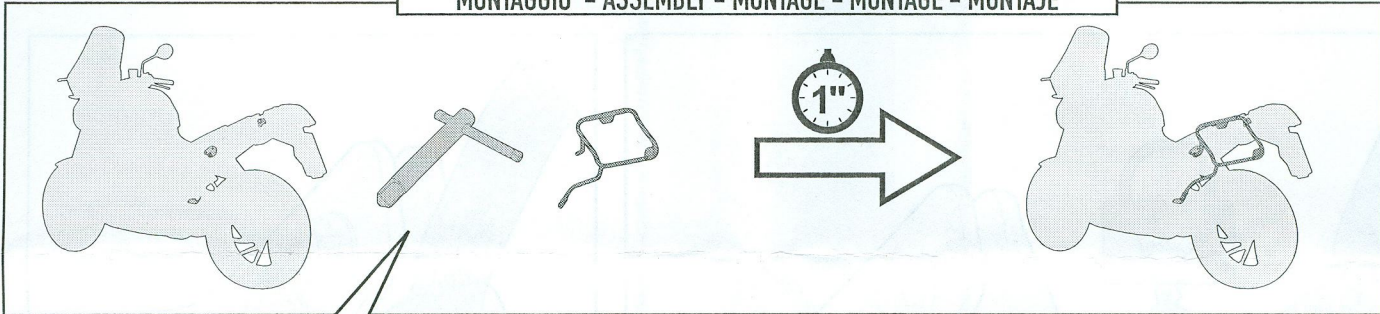

SMONTAGGIO - DISASSEMBLY - DÉMONTAGE - DEMONTAGE - DESMONTAJE

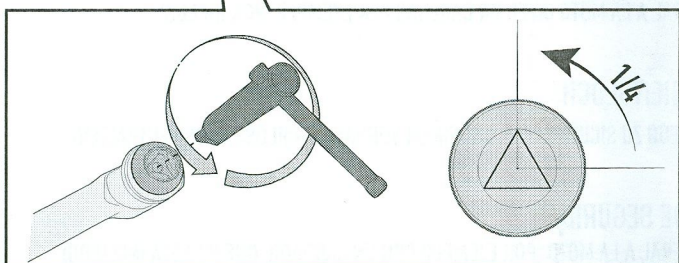
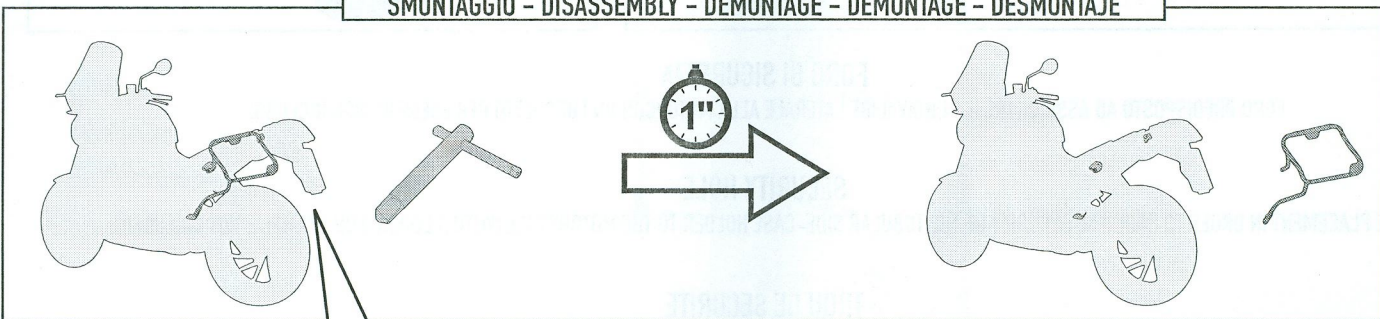

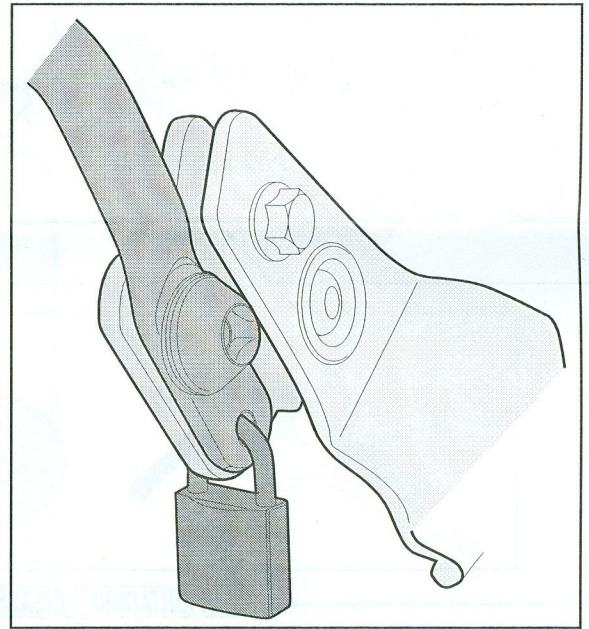
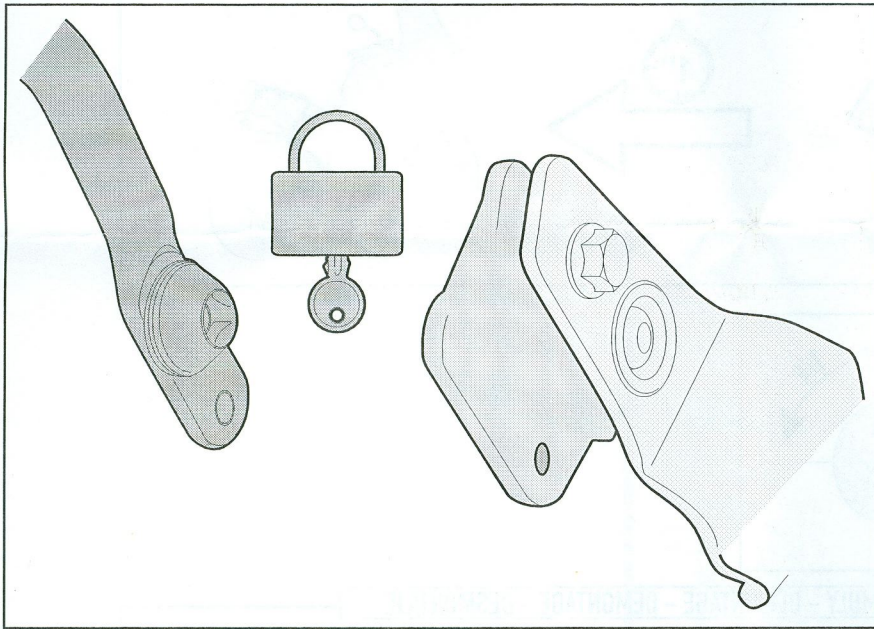
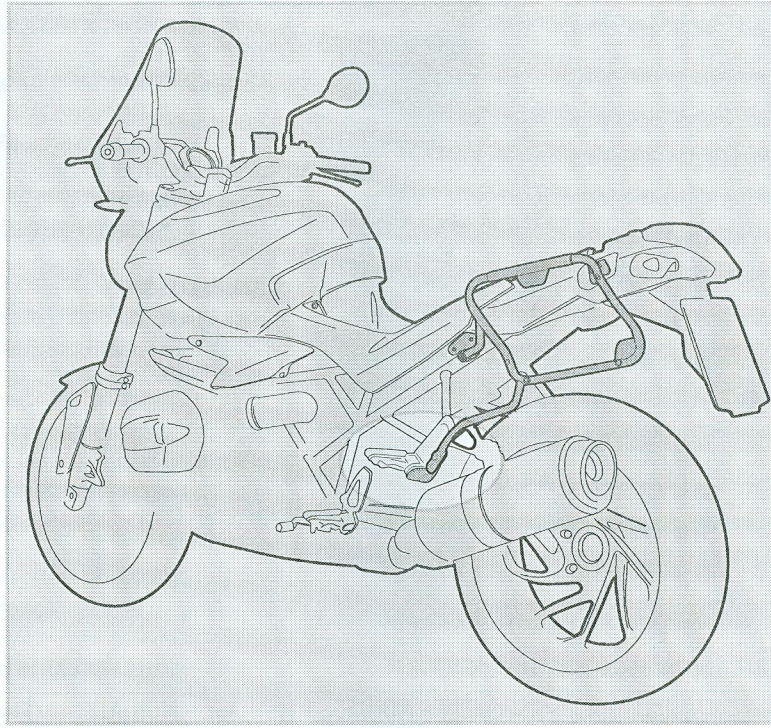

FORO DI SICUREZZA

FORO PREDISPOSTO AD ASSICURARE IL PORTAVALIGIE LATERALE ALLA MOTO (CON UN LUCCHETTO PER ESEMPIO, NON INCLUSO).

SECURITY HOLE

HOLE PLACEMENT IN ORDER TO INCREASE SECURITY OF THE TUBULAR SIDE-CASE HOLDER TO THE MOTORCYCLE (WITH A LOCK, FOR EXAMPLE, NOT INCLUDED).

TROU DE SECURITE

TROU PREDISPOSE POUR ASSURER LE PORTE-VALISE LATERAL A LA MOTO (AVEC UN CADENAS PAR EXEMPLE, NON INCLUS).

SICHERHEITSLÖCH

VORGESEHENES LOCH UM DEN SEITENKOFFER TRÄGER AN DEM FAHRZEUG ZU SICHERN (Z. B. MIT EINEM VORHÄNGSCHLOSS, NICHT ENTHALTEN);

ORIFICIO DE SEGURIDAD

ESTE ORIFICIO ESTA CREADO PARA ASEGURAR EL PORTAEQUIPAJES LATERAL A LA MOTO (POR EJEMPLO CON UN CANDADO, QUE NO ESTÁ INCLUIDO).